

Taymor

PRODUCT SPECIFICATIONS

THE PREMIER LINE

BARCELONA

KNOBSET



GRADE 3
ANSI GRADE 3



LIMITED LIFETIME MECHANICAL & FINISH WARRANTY

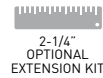

SPECIFICATIONS

- UNIVERSAL 6-IN-1 LATCH: DRIVE IN, SQUARE MORTISE AND RADIUS CORNER WITH ADJUSTABLE BACKSET: 2-3/8" (60 mm) – 2-3/4" (70 mm)
- STANDARD BORE HOLES: 2-1/8" (54 mm)
- FITS STANDARD DOOR THICKNESS: 1-3/8" (35 mm) – 1-3/4" (45 mm)
- FULL LIP RADIUS CORNER STRIKE WITH ADJUSTABLE TAB STANDARD: 1-3/4" x 2-1/4" (45 mm x 57 mm)

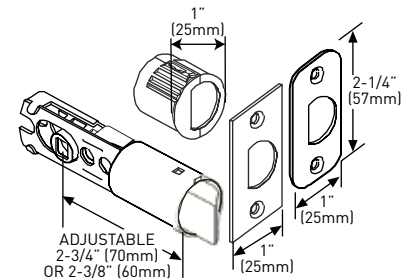
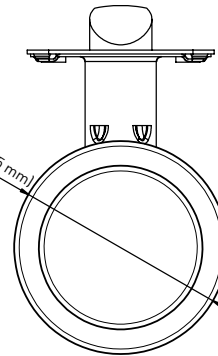
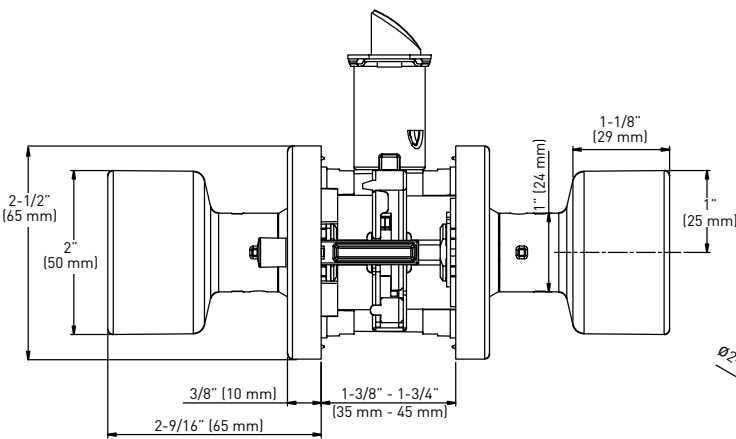

6-IN-1 PRIVACY/PASSAGE LATCH

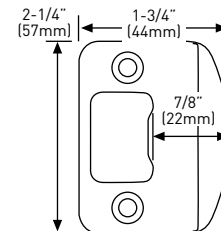

FULL LIP RADIUS STRIKE

BUILDER PACK	SATIN NICKEL 15	MATTE BLACK 19	POLISHED CHROME 26	CASE QTY
Privacy	30-D006124SN	30-D006124BLK	30-D006124PC	20
Passage	30-D006134SN	30-D006134BLK	30-D006134PC	20
Inside trim	30-HL0061SN	30-HL0061BLK	30-HL0061PC	20
Dummy	30-614SN	30-614BLK	30-614PC	20

SQUARE ROSE KIT OPTION



SQUARE CONTEMPORARY ROSE KIT

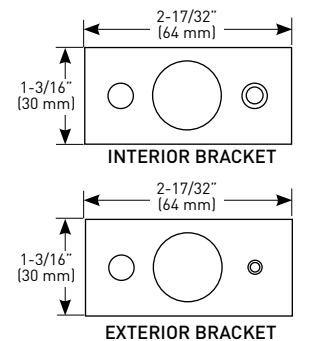
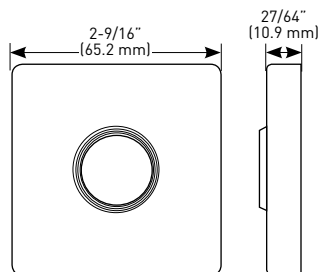

BUILDER PACK	AGED BRONZE 10B+	SATIN NICKEL 15	MATTE BLACK 19	POLISHED CHROME 26	SATIN CHROME 26D	CASE QTY
Privacy	30-SQR0024BRN	30-SQR0024SN	30-SQR0024BLK	30-SQR0024PC	30-SQR0024SC	10
Passage	30-SQR0034BRN	30-SQR0034SN	30-SQR0034BLK	30-SQR0034PC	30-SQR0024SC	10
Dummy/Inside trim	30-SQR0044BRN	30-SQR0044SN	30-SQR0044BLK	30-SQR0044PC	30-SQR0024SC	10

MEASUREMENTS SUBJECT TO A 3% VARIANCE

MEASUREMENTS ARE FOR REFERENCE ONLY. TAYMOR RESERVES THE RIGHT TO CHANGE THE PRODUCT SPECS WITHOUT NOTICE. FOR PRODUCT WARRANTY, PLEASE VISIT TAYMOR WEBSITE FOR DETAILS

